



PROCON
ELECTRONICS

Single Channel Loop Detector



Model - LD140 Series

The LD140 has been designed as a multipurpose inductive loop vehicle detector for use in parking, access control and traffic applications.

The detector is connected to an inductive loop mounted in the road surface. When vehicles pass over the loop the detector switches on an output.

The use of microprocessor and surface mount technology enables a large number of functions to be incorporated into a small package. The LD140 is compatible with most single channel detectors on the market and is easy to set-up and install.

The LD140 incorporates a LCD display for showing variables which assist with detector configuration and diagnostics.



Applications

Typical applications in the parking and access control environments are safety loops for barriers or gates, arming loops for activating card dispensers, entry or exit loops and vehicle counting.

Typical applications in the traffic environment are traffic control (traffic lights), toll systems and vehicle counting.

Features

Custom LCD Display. The custom liquid crystal display is used in conjunction with the two menu up/down push buttons to show configuration and diagnostic information, such as loop frequency and % Δ L/L value. The detector functions like a loop analyzer.

Enhanced User Interface. Allows for all functions to be programmed from the front panel LCD menus.

Loop Fail Diagnostics. Provides an indication of shorted loops and open circuit loops.

Automatic Tuning. This results in the detector re-tuning the sensing loop and becoming ready for vehicle detection. Also includes continuous environmental monitoring and tracking for optimal performance.

Vehicle Counter. Counts vehicles as they move over the loop. The counter keeps its value in the event of a power failure and has a maximum value of 999999.

Loop Protection. Uses a loop isolation transformer with zener diodes and gas discharge tube.

Reset Switch. Pressing the reset switch enables the detector to be manually reset during commissioning and testing. This results in the detector re-tuning the sensing loop and becoming ready for vehicle detection.

Programmable Features

- Selectable Detect Sensitivity
- Automatic Sensitivity Boost Option
- Filter Timer & Extend Timer
- Selectable Pulse Time
- Relay 2 Mode – Pulse on detect, pulse on undetect, presence or loop fault
- Presence Mode – Permanent or limited.
- Selectable Fail Safe/ Fail Secure operation
- Adjustable loop frequency
- Power fail memory

Technical Specifications

Power supply	LD140 200 - 260VAC 50Hz 1.5VA
	LD141 100 - 120VAC 60Hz 1.5VA
	LD142 11 - 26VAC/DC 50/60Hz 60mA max.
Presence Relay 1	Change over contact 0.5A/220VAC (Fail Safe – normally energized) (Fail Secure – normally denergised)
Pulse Relay 2	Change over contact 0.5A/220VAC (Pulse on detect – normally denergised) (Pulse on undetect – normally denergised) (Presence mode – normally denergised) (Loop fault mode – normally energised) (Detect on STOP mode – normally denergised)
Response time	Default approximately 120ms after vehicle enters loop. Adjustable 50ms to 9.00 seconds
Indicators	LED indicators show: Detect state.
Detector tuning range	15 - 1500uH
Loop Frequency	Approx. 23 – 130KHz
Power Fail Memory	20 Seconds
Environmental tracking	Automatic Compensation
Protection	Loop isolation transformer with zener diodes and gas discharge tube.
Connector	11 Pin Connector on rear of unit.
Dimensions	80mm (height) X 40mm (width) X 79mm (Depth excl. connector).
Operating Temperature	-20°C to +70°C
Storage Temperature	-40°C to +85°C

Note: This device has not been calibrated. The readings on the LCD display are for diagnostic purposes only.

Indicators

Detect Indicator. This LED Indicator is illuminated when there is a vehicle over the loop or the loop is faulty. This LED can also be used to determine the loop frequency. On reset, count the number of times the LED flashes. Multiply this number by 10KHz. If the LED flashes 6 times, then the loop frequency is between 60KHz and 70KHz.

Relay Functionality

RELAYS		VEHICLE PRESENT	NO VEHICLE	LOOP FAULTY	NO POWER
PRESENCE RELAY 1 (Fail Safe - SAF)	N/O	CLOSED	OPEN	CLOSED	CLOSED
	N/C	OPEN	CLOSED	OPEN	OPEN
PRESENCE RELAY 1 (Fail Secure - SEC)	N/O	OPEN	CLOSED	OPEN	CLOSED
	N/C	CLOSED	OPEN	CLOSED	OPEN
PULSE RELAY 2 (Pulse On Detect - ON)	N/O	PULSE CLOSED	OPEN	OPEN	OPEN
	N/C	PULSE OPEN	CLOSED	CLOSED	CLOSED
PULSE RELAY 2 (Pulse On UnDetect - OFF)	N/O	PULSE CLOSED	OPEN	OPEN	OPEN
	N/C	PULSE OPEN	CLOSED	CLOSED	CLOSED
PULSE RELAY 2 (Presence – Det & doS)	N/O	CLOSED	OPEN	OPEN	OPEN
	N/C	OPEN	CLOSED	CLOSED	CLOSED
PULSE RELAY 2 (Fault- FLT)	N/O	CLOSED	CLOSED	OPEN	OPEN
	N/C	OPEN	OPEN	CLOSED	CLOSED

Front Panel Controls

Front Panel Display and Controls. The drawing below shows the LCD display and the three push buttons.

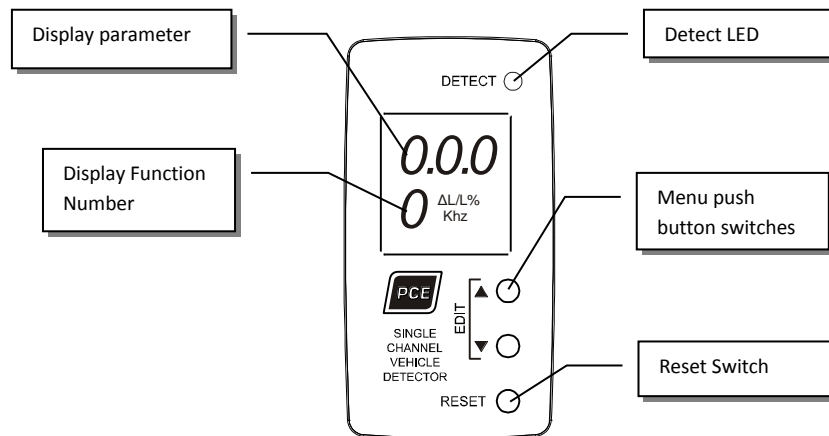

Menu push button switches. Pressing the up or down push button switches allows the operator to navigate through the menu on the LCD display. If both buttons are pressed at the same time, and if the menu is showing a configurable parameter, then the LD140 will enter Edit mode. The up/down push buttons are then used to select the desired value. Pressing the two buttons at the same time again will save the settings and exit Edit mode.

Display Function Number. This number shows which parameter is being currently displayed. The number changes as the up/down push buttons are pressed.

Display Parameter. This is the variable for the currently selected function.

Factory Default Parameters. To load the factory default settings press the up and down buttons together and while holding them in, press the reset button. Release the reset button and after 5 seconds release the up and down buttons.

Functions

Reset or Power Up. When the LD140 is reset the detector will begin to tune to the loop. Whilst this is being done the LCD displays the following startup information.

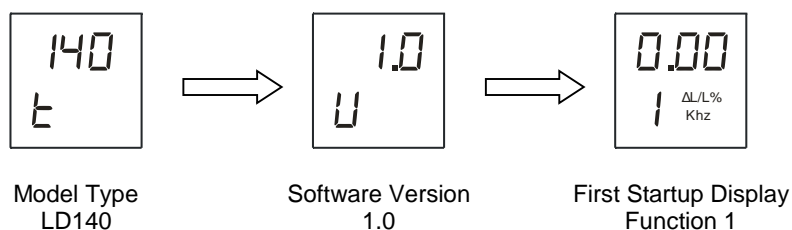

1 Change in Loop Inductance. The LCD displays the inductance change of the loop as the vehicle travels over the loop. This value is expressed as a percentage change in loop inductance. When no vehicle is present, the value will toggle about 0%. When a vehicle enters the loop area the value will increase until it reaches a maximum value determined by the size, shape and height of the vehicle. As the vehicle continues to pass over the loop the value will fluctuate as the loop senses different parts of the vehicle. When the vehicle leaves the loop the value will drop back to zero. When a vehicle enters the loop the value increases. As soon as the value is greater than the sensitivity setting, the detector presence output will give a detect output. This reading gives a good indication of the performance of the loop and assists with decision making in setting the sensitivity of the detector. This display is also used to show if there is a fault with the loop. The display will show “ShE” if there is a short circuit on the loop or the loop inductance is too small. The display will show “OPn” if the loop is open circuit or the loop inductance is too large.

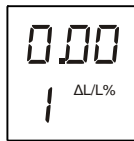

No Vehicle present on loop showing 0.00%

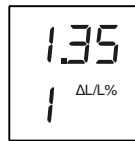

Vehicle on loop showing 1.35% change in loop inductance

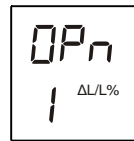

Loop error. Open circuit or too large

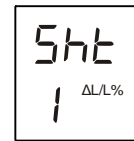

Loop error. Short circuit or too small

2 Loop Frequency. The loop frequency (Khz) is used to determine how close the loop detector is operating to the upper and lower limits of the working range (23 – 130 Khz). The loop frequency is also useful to determine how close in frequency the loop is operating to an adjacent loop to prevent problems with crosstalk.



Loop Frequency 57.1 Khz

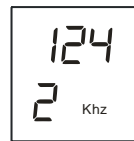

Loop Frequency 124 Khz

3 Detect Sensitivity. There are 23 selectable sensitivity levels. The detect sensitivity is the minimum change in inductance required to produce a detect output when the vehicle enters the loop. (%ΔL/L).

Sensitivity	%ΔL/L	Sensitivity	%ΔL/L	Sensitivity	%ΔL/L
1	0.01 %	9	0.09 %	17	0.80 %
2	0.02 %	10	0.10 %	18	0.90 %
3	0.03 %	11	0.20 %	19	1.00 %
4	0.04 %	12	0.30 %	20	2.00 %
5	0.05 %	13	0.40 %	21	3.00 %
6	0.06 %	14	0.50 %	22	4.00 %
7	0.07 %	15	0.60 %	23	5.00 %
8	0.08 %	16	0.70 %	-	-

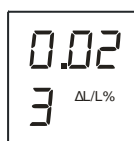

Detector Sensitivity 0.02%

- To change the sensitivity:
1. Push up and down buttons together to enter edit mode.
 2. Use up or down buttons to select sensitivity.
 3. Push up and down buttons together to exit edit mode.

4 Automatic Sensitivity Boost. This feature sets the undetect level to maximum sensitivity and is used to prevent loss of detection of high-bed vehicles.

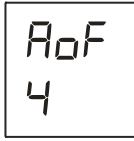

Automatic Sensitivity
Boost Disabled
OFF

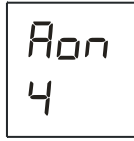

Automatic Sensitivity
Boost enabled
ON

To change the ASB:

1. Push up and down buttons together to toggle mode.

5 Filter Timer. This timer is used to provide a delay between detection of the vehicle and switching of the output relay. This delay is normally used to prevent false detection of small or fast moving objects.

Filter	Seconds	Filter	Seconds	Filter	Seconds	Filter	Seconds
1	0.05	8	0.15	15	0.80	22	6.00
2	0.06	9	0.20	16	0.90	23	7.00
3	0.07	10	0.30	17	1.00	24	8.00
4	0.08	11	0.40	18	2.00	25	9.00
5	0.09	12	0.50	19	3.00	-	-
6	0.10	13	0.60	20	4.00	-	-
7	0.12	14	0.70	21	5.00	-	-

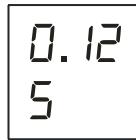

Filter Timer
0.12 seconds

To change the filter:

1. Push up and down buttons together to enter edit mode.
2. Use up or down buttons to select the value.
3. Push up and down buttons together to exit edit mode.

6 Extend Timer. This feature extends the presence output relay after the vehicle has left the loop.

Extend	Seconds	Extend	Seconds	Extend	Seconds	Extend	Seconds
1	0.05	8	0.15	15	0.80	22	6.00
2	0.06	9	0.20	16	0.90	23	7.00
3	0.07	10	0.30	17	1.00	24	8.00
4	0.08	11	0.40	18	2.00	25	9.00
5	0.09	12	0.50	19	3.00	-	-
6	0.10	13	0.60	20	4.00	-	-
7	0.12	14	0.70	21	5.00	-	-

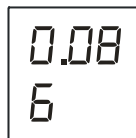

Extend Timer
0.08 seconds

To change the Extend:

1. Push up and down buttons together to enter edit mode.
2. Use up or down buttons to select the value.
3. Push up and down buttons together to exit edit mode.

7 Selectable Pulse Time. This feature sets the length of time that the pulse relay will be energized.

Pulse	Seconds	Pulse	Seconds	Pulse	Seconds	Pulse	Seconds
1	0.05	8	0.15	15	0.80	22	6.00
2	0.06	9	0.20	16	0.90	23	7.00
3	0.07	10	0.30	17	1.00	24	8.00
4	0.08	11	0.40	18	2.00	25	9.00
5	0.09	12	0.50	19	3.00	-	-
6	0.10	13	0.60	20	4.00	-	-
7	0.12	14	0.70	21	5.00	-	-



Pulse Timer
0.20 seconds

To change the Pulse Time:

1. Push up and down buttons together to enter edit mode.
2. Use up or down buttons to select the value.
3. Push up and down buttons together to exit edit mode.

B Relay 2 Mode. The Pulse relay 2 may be configured to operate in four different modes:

- a. "On" - To energize on detection of a vehicle for the duration of the pulse time.
- b. "OFF" - To energize when the vehicle leaves the loop for the duration of the pulse time.
- c. "dEt" - As a second detector presence output (fail secure).
- d. "FLt" - As a loop fault output (normally used in traffic applications).
- e. "doS" - Detect on STOP. Uses the pulse time (fail secure). From V3.0

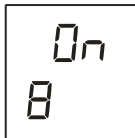

Relay 2 Mode
Pulse On detect
On

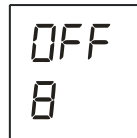

Relay 2 Mode
Pulse On undetect
OFF

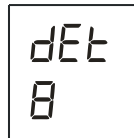

Relay 2 Mode
Presence Mode
dEt

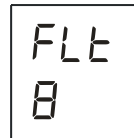

Relay 2 Mode
Loop Fault Mode
FLt

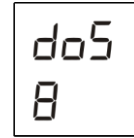

Relay 2 Mode
Detect On STOP
Mode
doS

To change the Relay 2 Mode:

1. Push up and down buttons together to enter edit mode.
2. Use up or down buttons to select the mode.
3. Push up and down buttons together to exit edit mode.

9 Presence Mode. The presence time can be configured for an unlimited time depending on the value of the % Δ L/L, a limited time or for permanent presence. The limited time presence is normally used in traffic applications. The permanent presence feature ensures detection of the vehicle will be maintained when the vehicle is parked over the loop for extended periods.

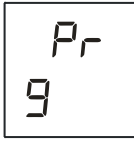

Normal mode. Presence limited by % Δ L/L.

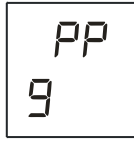

Permanent Presence

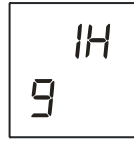

Presence limited to 1 Hour.

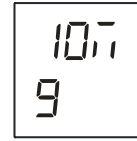

Presence limited to 10 Minutes.

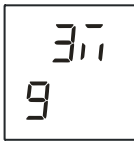

Presence limited to 3 Minutes.

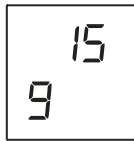

Presence limited to 1 Second. Passage Mode

To change the Presence Mode:

1. Push up and down buttons together to enter edit mode.
2. Use up or down buttons to select the value.
3. Push up and down buttons together to exit edit mode.

A Selectable Fail Safe/ Fail Secure. The presence relay 1 can be configured to operate in two modes:

- a. "SAF" - Fail safe operation.
- b. "SEC" - Fail secure operation.



Fail safe operation enabled

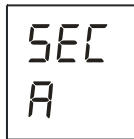

Fail secure operation enabled

To change the Relay 1 Mode:

1. Push up and down buttons together to toggle mode.

b Adjustable loop frequency. The loop frequency can be adjusted for high or low frequency operation. This feature is used to adjust the loop frequency to prevent crosstalk with an adjacent loop on another loop detector.

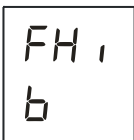

Loop Frequency High

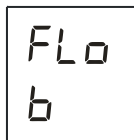

Loop Frequency Low

To change the Loop Frequency:

1. Push up and down buttons together to toggle mode.

- C Power fail memory.** A new standard feature on the LD140 is a power fail memory facility. Should a power loss occur, the detector has the ability to remember if a vehicle is present on the loop eliminating a retune event when power is restored. This is ideal for applications where the loop detector is used as a safety device i.e. on barrier applications or rising bollards.

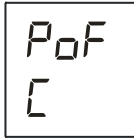

Power fail memory
Disabled

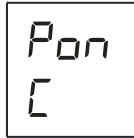

Power fail memory
Enabled

To change the Power fail mode:

1. Push up and down buttons together to toggle mode.

- d Vehicle Counter.** Counts vehicles as they move over the loop. The counter keeps its value in the event of a power failure and has a maximum value of 999999. The display is only 3 digits wide, so in order to read the six digit counter, the first three digits are displayed while flashing (**123xxx**) and then the last three digits are displayed (**xxx456**). This cycle is performed continuously. To reset the counter to zero press the up and down buttons simultaneously.

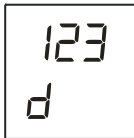

Counter High digits
Flashing

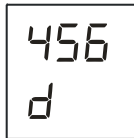

Counter Low digits

The first three digits are shown flashing. The last three digits do not flash.

To reset the count to zero:

1. Push up and down buttons together.

- E MAX $\Delta L/L$** or maximum change in inductance from the tuned value. This value is reset after the vehicle passes the loop. Whilst over the loop the detector records the peak change in inductance caused by the vehicle.

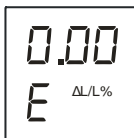

No vehicle on loop.

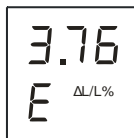

Vehicle on Loop.
Maximum change in
inductance shown.

This function cannot be edited.

F MIN $\Delta L/L$ or minimum change in inductance from the tuned value. This value is recorded as a vehicle passes over the loop and is displayed as the vehicle leaves the loop. This value is useful in determining the minimum change in inductance caused by vehicles over a period of time. This value is updated as each vehicle passes over the loop. If the change in inductance caused by a vehicle was greater than the previous vehicle, then the reading is not changed. If the change in inductance is smaller than the previous vehicle, then the reading is updated with the latest reading. Again this value is useful in determining the optimum sensitivity setting. To reset the reading to 9.99 press the up and down buttons simultaneously.

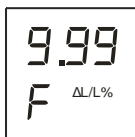

Display has been reset to 9.99%

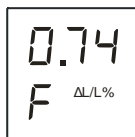

Vehicle has been on and off Loop. Minimum change displayed 0.74%

To reset the reading:
1. Push up and down buttons together.

Diagnosics

SYMPTOM	POSSIBLE CAUSE	SOLUTION
The LCD display is not on.	No power supply voltage on the input.	Check that the power supply is correctly wired to the detector. (PINS 1 and 2)
The DETECT LED flashes erratically or the change in inductance value on the display changes very quickly with no vehicle present.	There may be a poor connection in the loop or loop feeder. The detector may be experiencing crosstalk with the loop of an adjacent detector.	Check all wiring. Tighten screw terminals. Check for broken wires. Try changing frequencies using the frequency switch. Put the detector with the larger loop onto low frequency and the detector with the smaller loop onto high frequency.
The DETECT LED randomly stays on.	Faulty loop or loop feeder wiring. Movement of the loop in the ground.	Check the wiring. Tighten screw terminals. Check for pinched or bent wires. Is the feeder wire twisted? Check for cracks in the road surface near the loop.
The LCD display is showing 5hL.	The loop inductance is too small or the loop is short circuit.	Check that there is no short circuit on the loop feeder wiring or the loop. If there is no short circuit then the inductance is too small and more turns of wire should be added to the loop.
The LCD display is showing 0Pn.	The loop inductance is too large or the loop is open circuit.	Check that there is electrical continuity on the loop. This can be done using a multimeter on the ohms range (< 5 Ω). If the loop inductance is too large then try reducing the number of turns.

Typical Configurations

The following table shows some standard settings for various applications of the LD140. The user must change these settings to suit the application.

Function Number	Access Control (Gate/Door activation)	Parking (Barrier/Gate Safety) Cars	Parking (Barrier/Gate Safety) Trucks	Traffic (Traffic Light Actuation)
3	0.05 3 $\Delta/L\%$	0.05 3 $\Delta/L\%$	0.01 3 $\Delta/L\%$	0.02 3 $\Delta/L\%$
4	AoF 4	Aon 4	Aon 4	AoF 4
5	0.12 5	0.12 5	0.12 5	0.05 5
6	0.08 6	0.08 6	0.08 6	0.05 5
7	0.20 7	0.20 7	0.20 7	0.20 7
8	On 8	On 8	On 8	FLt 8
9	Pr 9	Pr 9	Pr 9	10n 9
A	SAF A	SAF A	SAF A	SEC A
C	PoF C	Pon C	Pon C	PoF C

Wiring Diagram

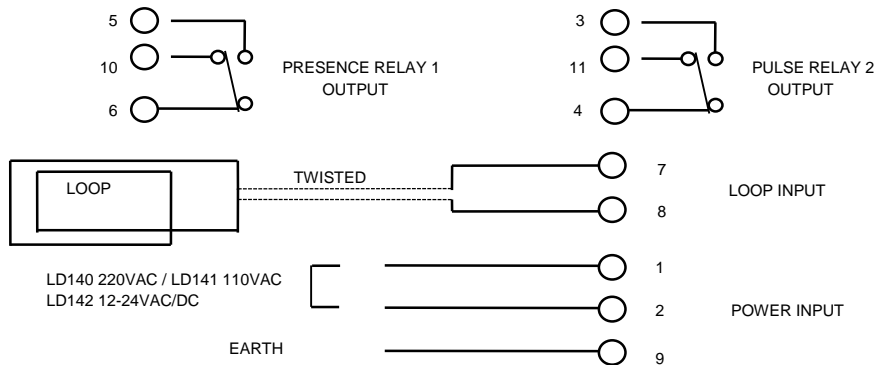

Loop Installation Guide

1. The detector should be installed in a waterproof housing as close to the loop as possible.
2. The loop and feeder should be made from insulated copper wire with a minimum cross-sectional area of 1.5mm^2 . The feeder should be twisted with at least 20 turns per metre. Joints in the wire are not recommended and must be soldered and made waterproof. Faulty joints could lead to incorrect operation of the detector. Feeders which may pick up electrical noise should use screened cable, with the screen earthed at the detector.
3. The loop should be either square or rectangular in shape with a minimum distance of 1 metre between opposite sides. Normally 3 turns of wire are used in the loop. Large loops with a circumference of greater than 10 metres should use 2 turns while small loops with a circumference of less than 6 metres should use 4 turns. When two loops are used in close proximity to each other it is recommended that 3 turns are used in one and 4 turns in the other to prevent cross-talk.
4. Cross-talk is a term used to describe the interference between two adjacent loops. To avoid incorrect operation of the detector, the loops should be at least 2 metres apart and on different frequency settings.
5. For loop installation, slots should be cut in the road using a masonry cutting tool. A 45° cut should be made across the corners to prevent damage to the wire on the corners. The slot should be about 4mm wide and 30mm to 50mm deep. Remember to extend the slot from one of the corners to the road-side to accommodate the feeder.
6. Best results are obtained when a single length of wire is used with no joints. This may be achieved by running the wire from the detector to the loop, around the loop for 3 turns and then back to the detector. The feeder portion of the wire is then twisted. Remember that twisting the feeder will shorten its length, so ensure a long enough feeder wire is used.
7. After the loop and feeder wires have been placed in the slot, the slot is filled with epoxy compound or bitumen filler.

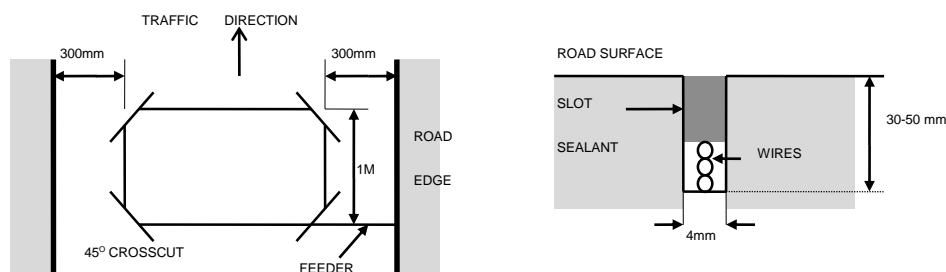

LD140 Configuration

1. Connect the wiring according to the pin-out on the side label of the detector.

- 1.1 Connect the power supply to the terminals 1 & 2.
- 1.2 Connect the loop to the terminals 7 & 8.
- 1.3 Connect the relay outputs as required. The relays are fail safe (factory default) and the normally open/normally closed contacts are indicated with the detector switched on and tuned to the loop, with no vehicle on the loop.

2. The next step is setting the configuration parameters on the display.

- 2.1 Set up the desired detect sensitivity (function **3**). The factory default is 0.02%.
- 2.2 Select Automatic sensitivity boost (function **4**). The factory default is disabled, *P_{oF}*.
- 2.3 The filter delay (function **5**) is used to delay the switching ON of the detector when a vehicle moves onto the loop. The factory default is 120ms.
- 2.4 The Extend delay (function **6**) is used to keep the presence relay switched on for a short period after the vehicle has left the loop. This is used to prevent the detector from giving a false undetect. The factory default is 80ms.
- 2.5 The pulse time (function **7**) is used to set the duration of the pulse relay. The factory default is 200ms.
- 2.6 The relay 2 mode (function **8**) is used to configure the pulse relay. The factory default is pulse on detect.
- 2.7 The permanent presence (function **9**) is used when the loop detector must detect a vehicle for hours or days at a time. For example in a parking bay. Keep this off for normal use.
- 2.8 The relay 1 mode (function **A**) is used to configure the presence relay. The factory default is fail safe.
- 2.9 The frequency (function **b**) is used to change the loop frequency. If the loop detector is experiencing interference from an adjacent detector (crosstalk) or from another source, the problem can be eliminated by switching this switch on. For normal operation this setting is *FH*.
- 2.10 Set up the desired power fail mode (function **C**). The factory default is disabled, *P_{oF}*.

Powering up and testing the LD140

1. Switch on the power and observe the LED and LCD display on the front of the detector.
2. The LCD display is an indication of power and must always be on.
3. The detect light indicates if there is a vehicle present on the loop. When the power is first applied to the detector this light flashes a couple of times indicating that the detector has tuned to the loop. The number of flashes indicates the frequency of the oscillator multiplied by 10 KHz (Kilohertz). For example, 7 flashes indicates that the loop frequency is between 70 and 80 KHz. If this light does not flash and stays on there is a problem with the loop or wiring.
4. The function (*I*) on the LCD display indicates change in inductance or loop fault. Some of the common problems are:
 - a. The loop wires have a short circuit. Check the wiring.
 - b. The loop inductance is too small. More turns must be added to the loop. For a 2m by 1m loop 3 turns is suitable. A wire size of 1.5mm² cross sectional area is recommended.
 - c. The loop inductance is too big. This is very seldom a problem as most loops have an inductance of less than 500uH. A solution is to reduce the number of turns on the loop.
 - d. The loop is open circuit. Check the wiring.

If the detector is erratic the problem may be more difficult to find. The first step is to check the loop wiring. Many intermittent problems can be attributed to poor wiring connections and even movement in the loop. The next step is to change the loop frequency, and finally it may be necessary reduce the loop sensitivity.

Care must be given to the placement of the loop. The loop should not be put below reinforcing mesh, should be kept away from any metal objects such as a manhole and should also not be too close to sliding gates, etc.



Contact Details



Refer to our web site for distributor details.

Email: proconel@proconel.com

Web: www.proconel.com